

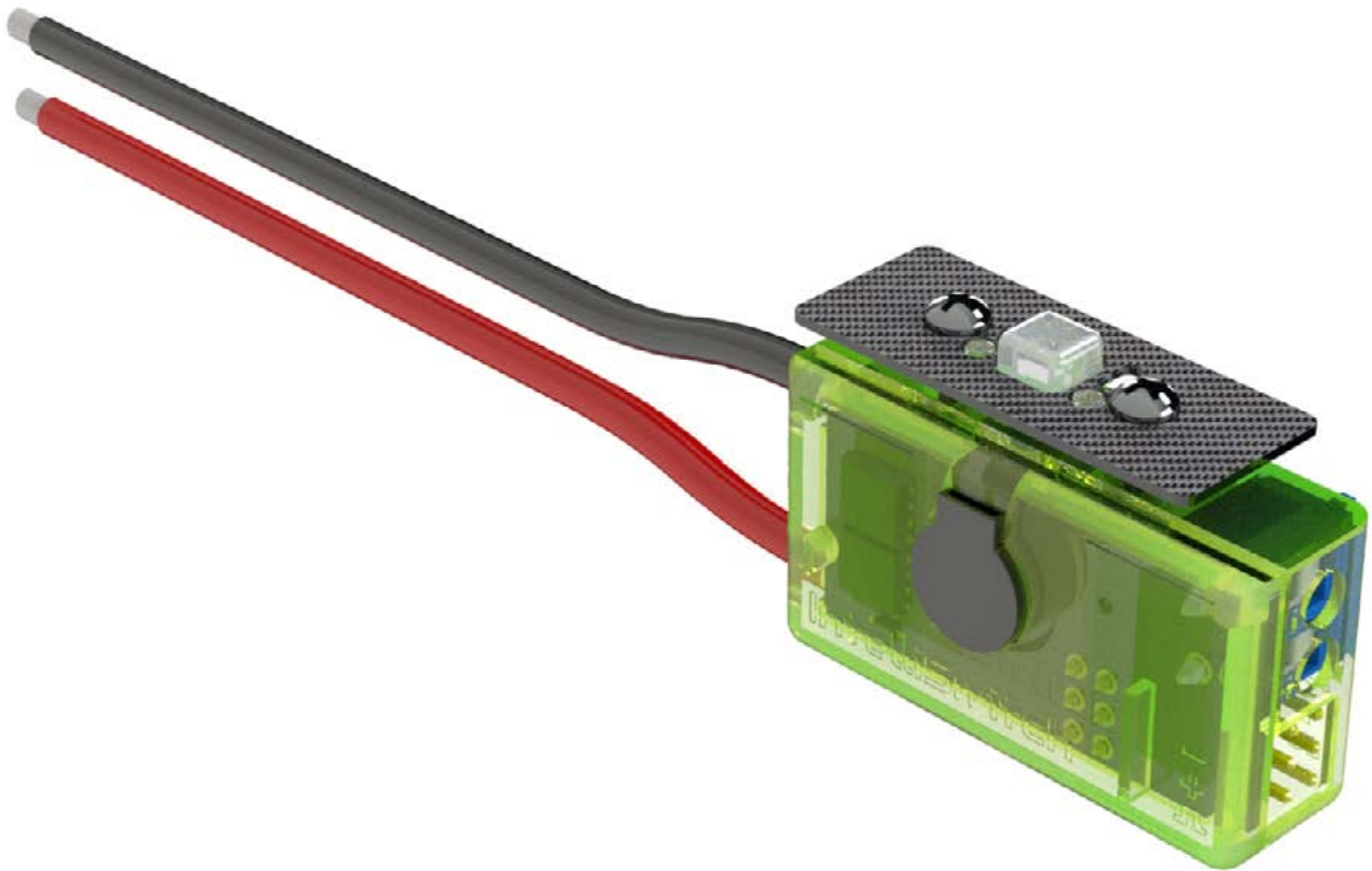

XGuard IntelliSwitch



Users Guide

Copyright 2021 XGuard RC. All rights reserved



LIABILITY DISCLAIMER

This device is for use exclusively on a radio controlled (RC) model. RC models are not toys. Moving parts can present a hazard to operators, bystanders and anyone or anything that could be reached by the RC model. Improper operation, maintenance or assembly can potentially cause an RC Model to pose a danger to persons or objects including but not limited to the possibility of causing serious physical injury and even death. After leaving its facilities the manufacturer has no way of maintaining control or supervision over the assembly and/or operation of the RC model or the addition of this device to the RC Model therefore the manufacturer and/or its agents assume no responsibility or liability whatsoever for any damages including but not limited to ones generated by incidental or consequential damages. The operator of the RC Model assumes all responsibility and liability that could result from the correct or incorrect operation of the RC Model and/or malfunction of any part or device used.



This product is intended to be used by experienced adult radio control model operators under controlled safety conditions and on locations properly authorized and setup for safe flying and away from other people. This product must not be operated without reasonable personal or commercial Liability Insurance.



Under no circumstance should a minor be allowed to operate any radio controlled model without the approval, supervision and direction of his/her parent or legal guardian who takes full responsibility and assumes full liability of every kind for the minor's actions.



Do not operate an RC models within the vicinity of homes, trees, electrical lines during inclement weather or rain or near crowds of people.

CONTENTS

PORTS DIAGRAM	4
CORRECT BATTERY CONNECTOR POLARITY.....	5
CONNECTION FOR HIGHER CURRENTS.....	6
MOUNTING THE SWITCH	7
LOCATOR ALARM SWITCHED ON BY RADIO SWITCH.....	8
SWITCH OPERATION	9
PROGRAMMING THE UNIT.....	10
ENTERING PROGRAMMING MODE	11
QUICK PROGRAMMING SEQUENCE GUIDE	11
MUSICAL TONES MEANING	12
DIMENSIONS	13
INSTALLATION HOLE PATTERN.....	13

XGuard IntelliSwitch

PORTS DIAGRAM

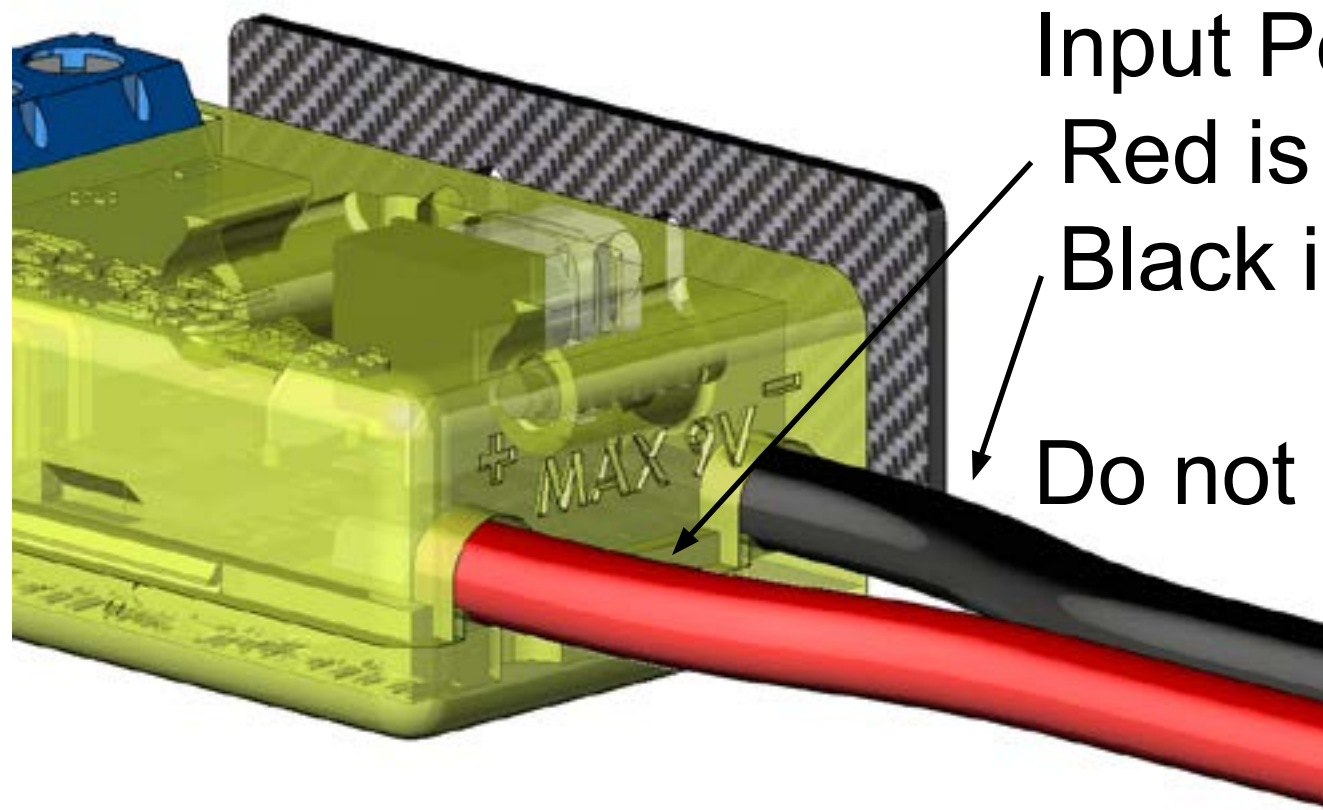

Input Port:

Red is Positive (MAX 9 Volts DC)

Black is Negative (GND)

Do not use higher voltage than 2S LiPo batteries. **Overvoltage or Reverse voltage damage is not covered by warranty**

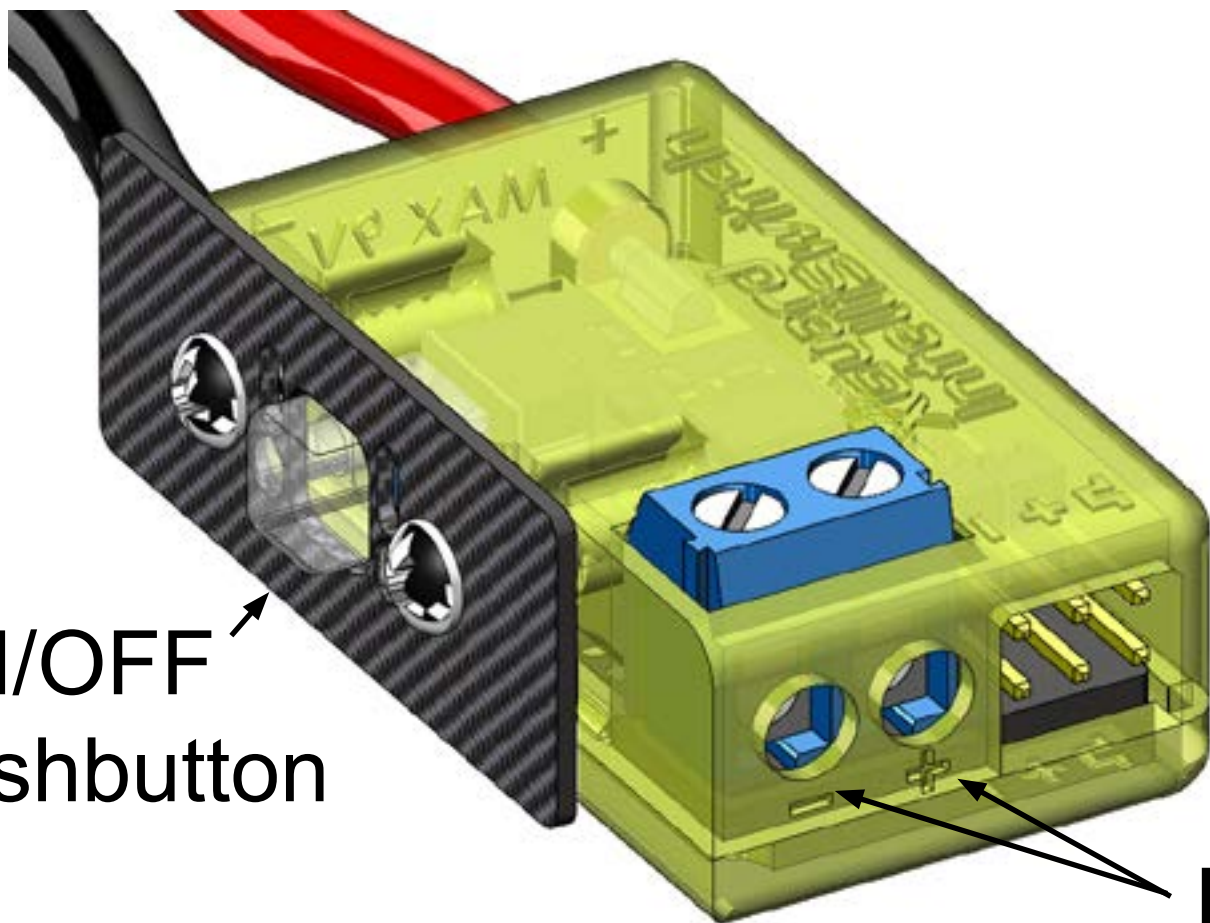

ON/OFF
Pushbutton

← Output 1 & Locator Switch (TOP)

← Output 2 (BOTTOM)

High-Current Output Port

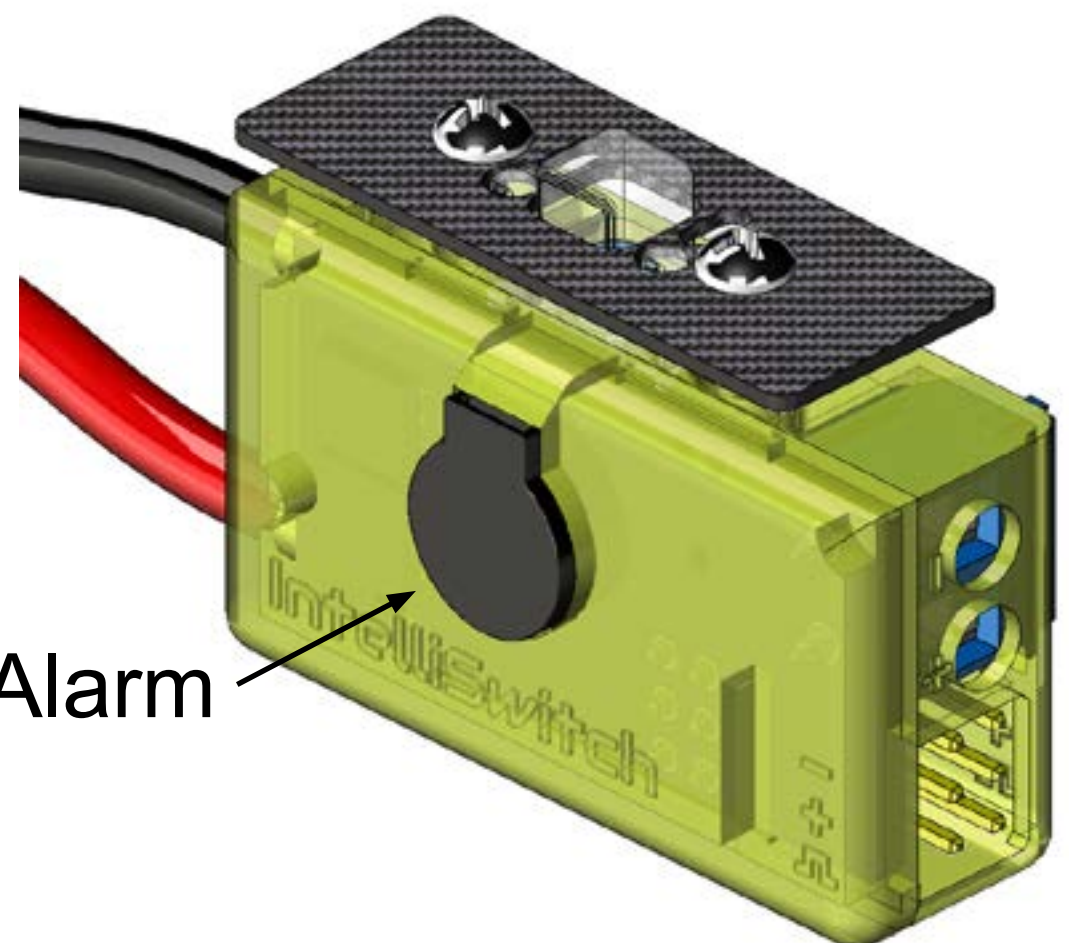

Buzzer/Alarm

CORRECT BATTERY CONNECTOR POLARITY

A) Polarity for an EC-3 Connector

EC3 Connector
(Not Included)

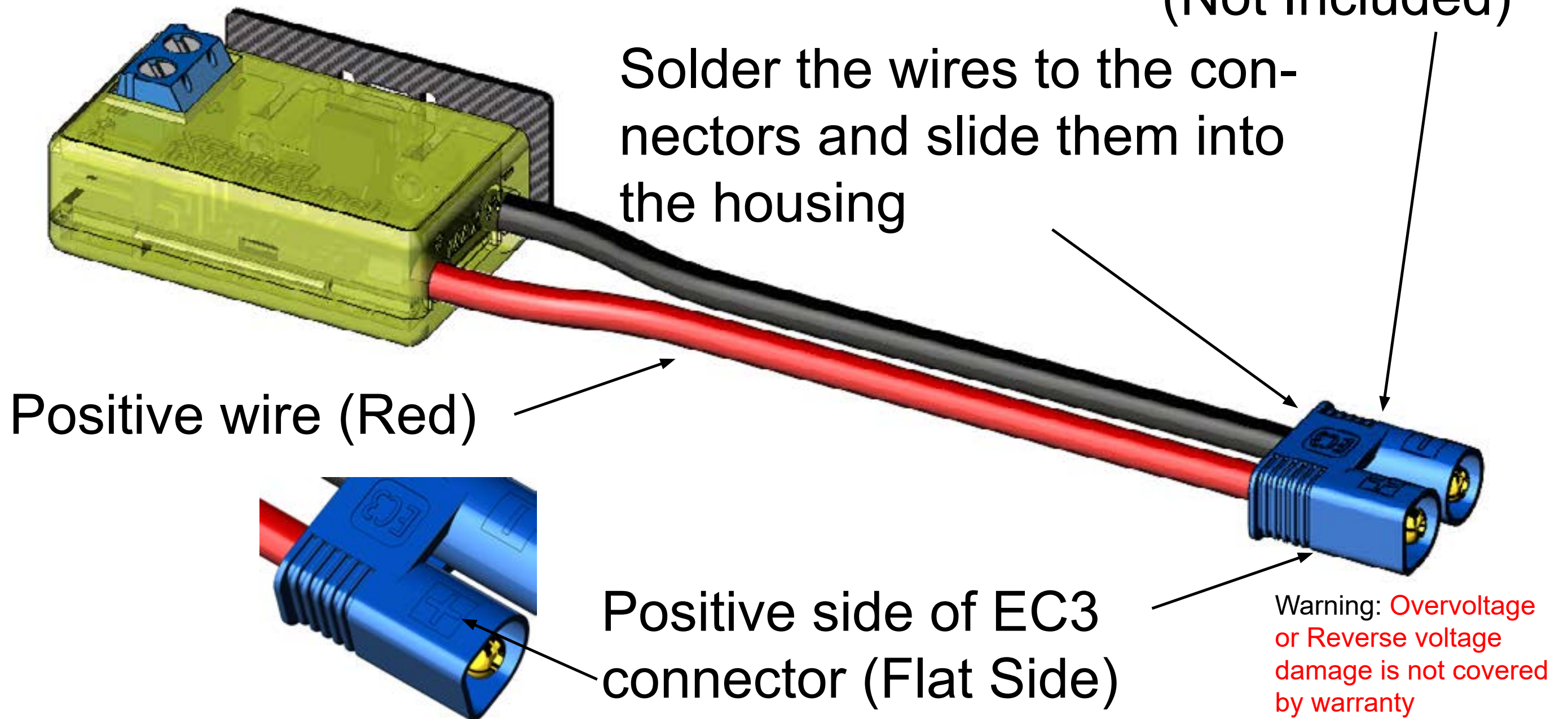

B) Polarity for an XT60 Connector

XT60 Connector
(Not Included)

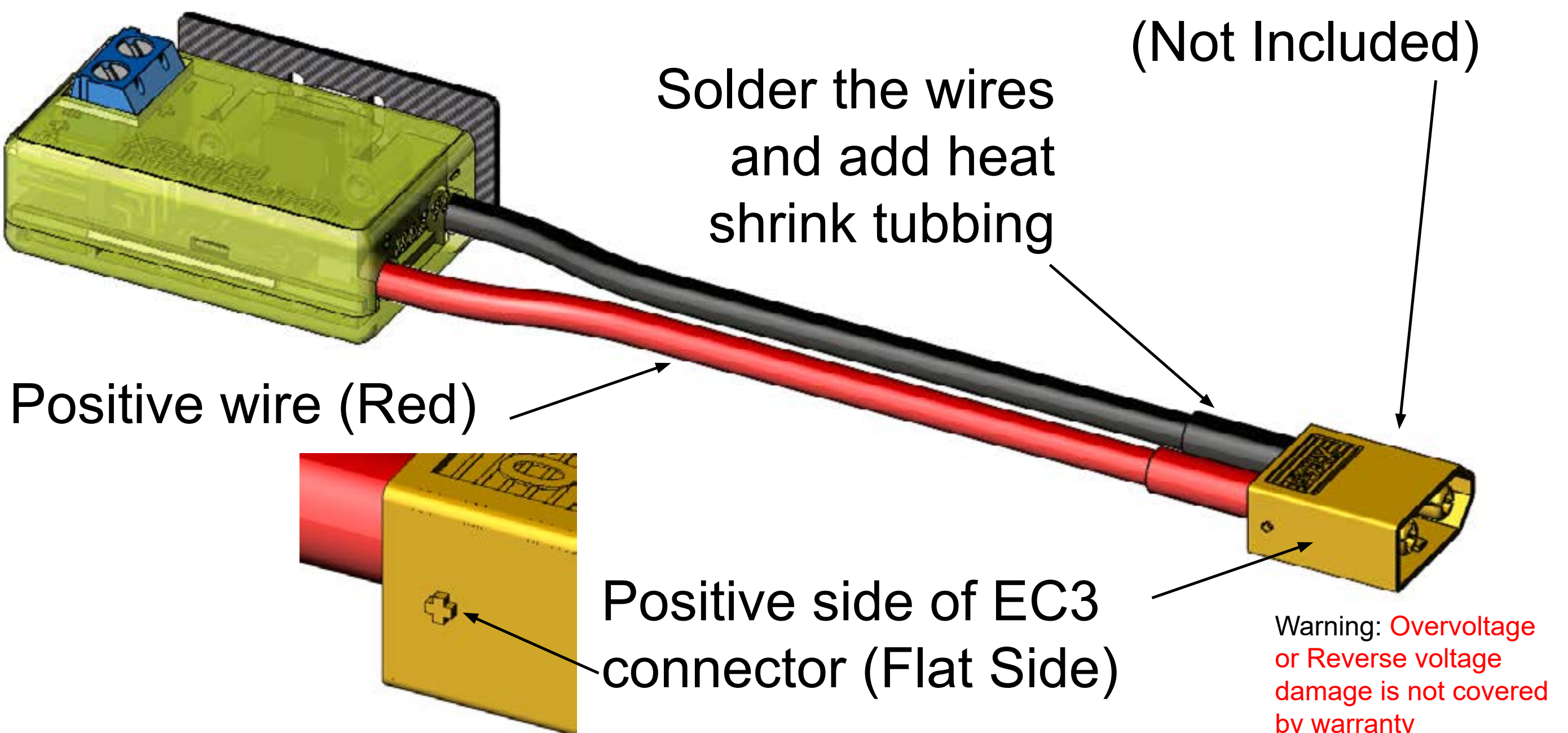

XGuard IntelliSwitch

CONNECTION FOR HIGHER CURRENTS

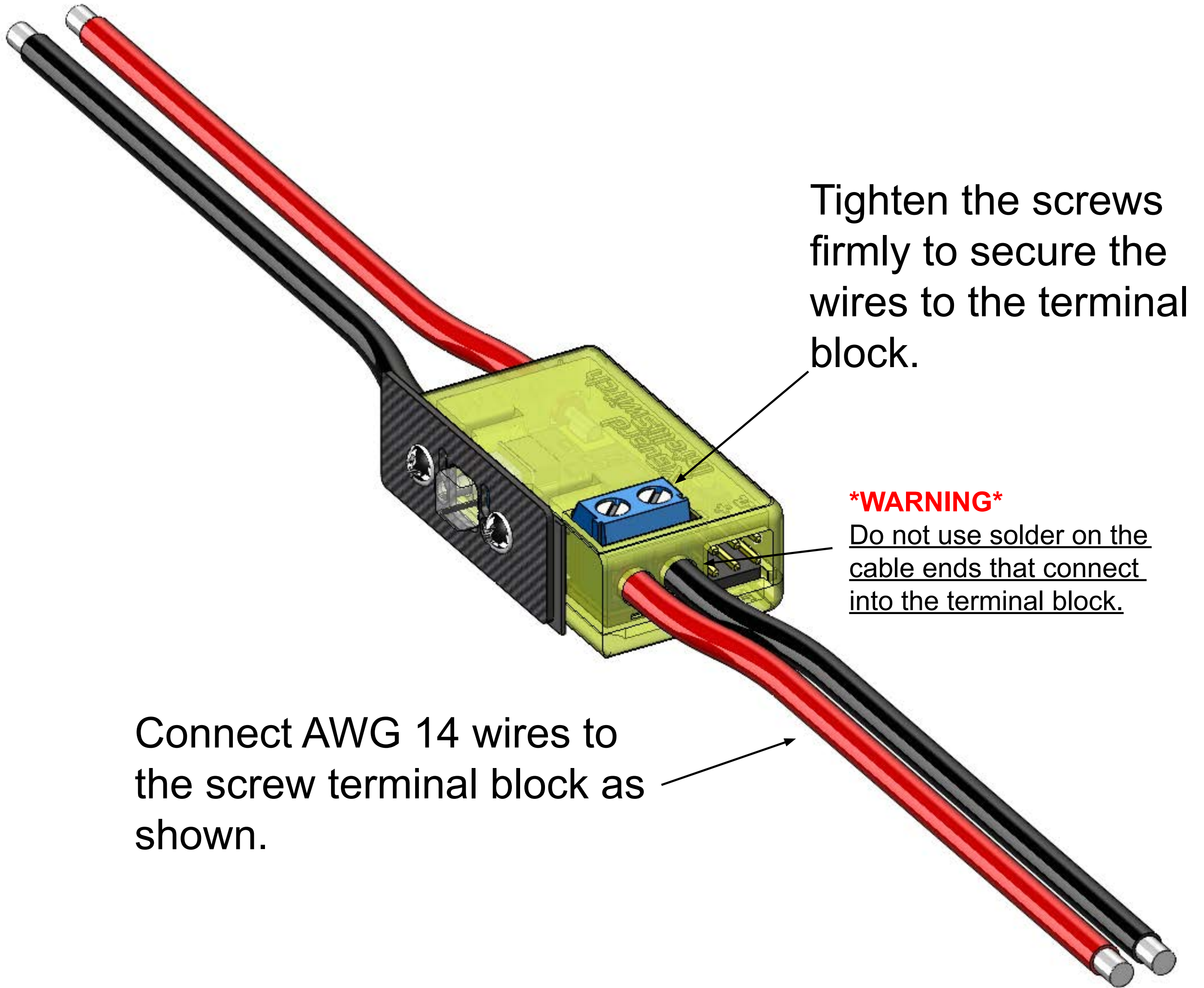

Tighten the screws firmly to secure the wires to the terminal block.

WARNING

Do not use solder on the cable ends that connect into the terminal block.

Connect AWG 14 wires to the screw terminal block as shown.

MOUNTING THE SWITCH

A) Double-Sided Tape

Use two pads of double-sided tape 1mm or thicker on the buzzer side to attach to a clean surface of your aircraft

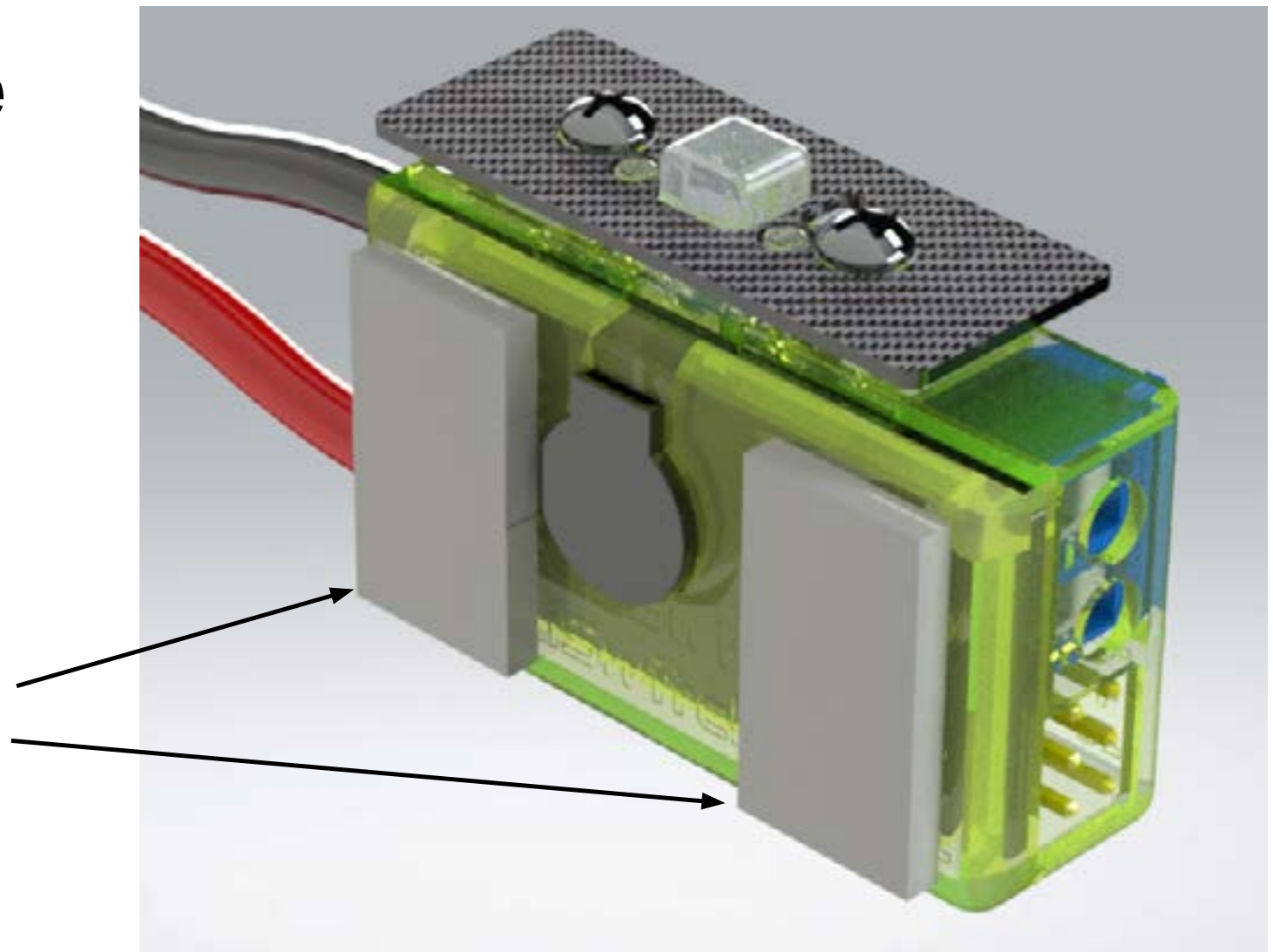

B) Panel Mount

Make sure that your panel mounting hole dimensions are at least the size of the ones in this diagram.

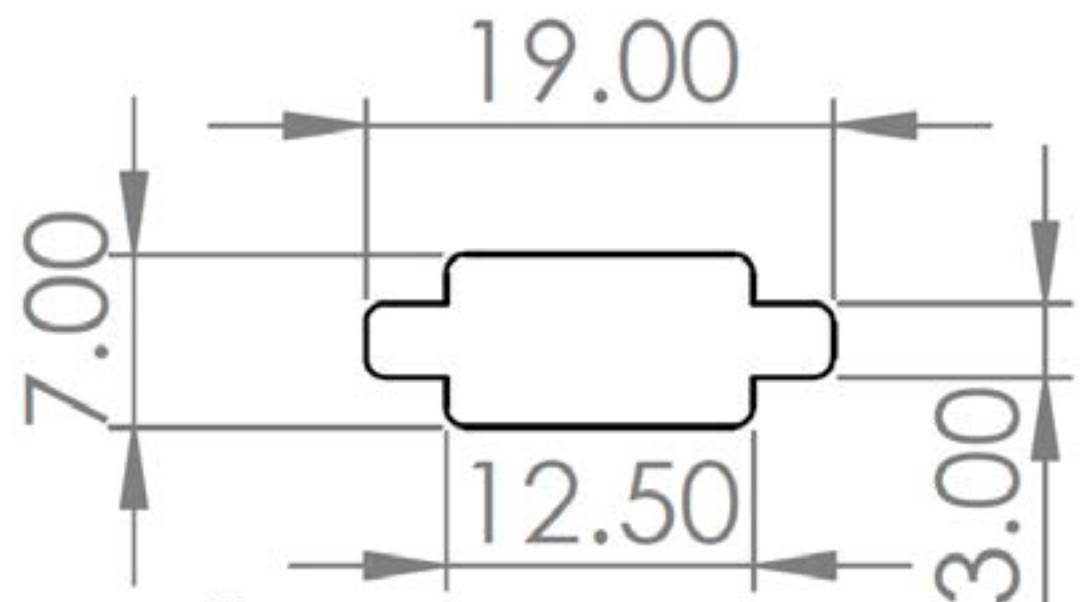

Mount the switch using the supplied screws and carbon fiber cover plate.

WARNING: Do not over-tighten the screws or you will break the plastic thread.

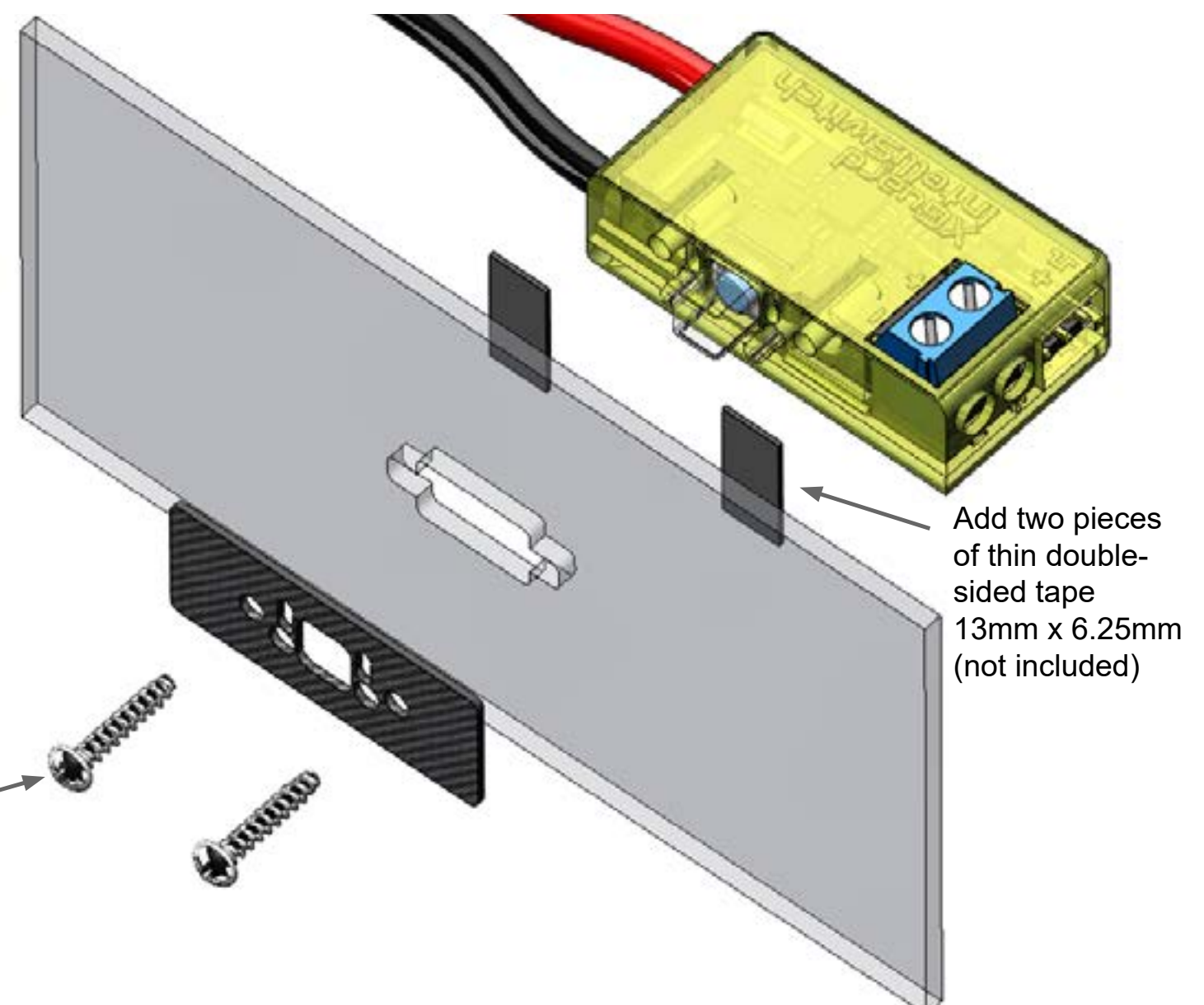

LOCATOR ALARM SWITCHED ON BY RADIO SWITCH

Program an unused channel like AUX1 to be controlled by a switch. Use this channel to turn on or off the locator buzzer by plugging it to the top port as shown below.

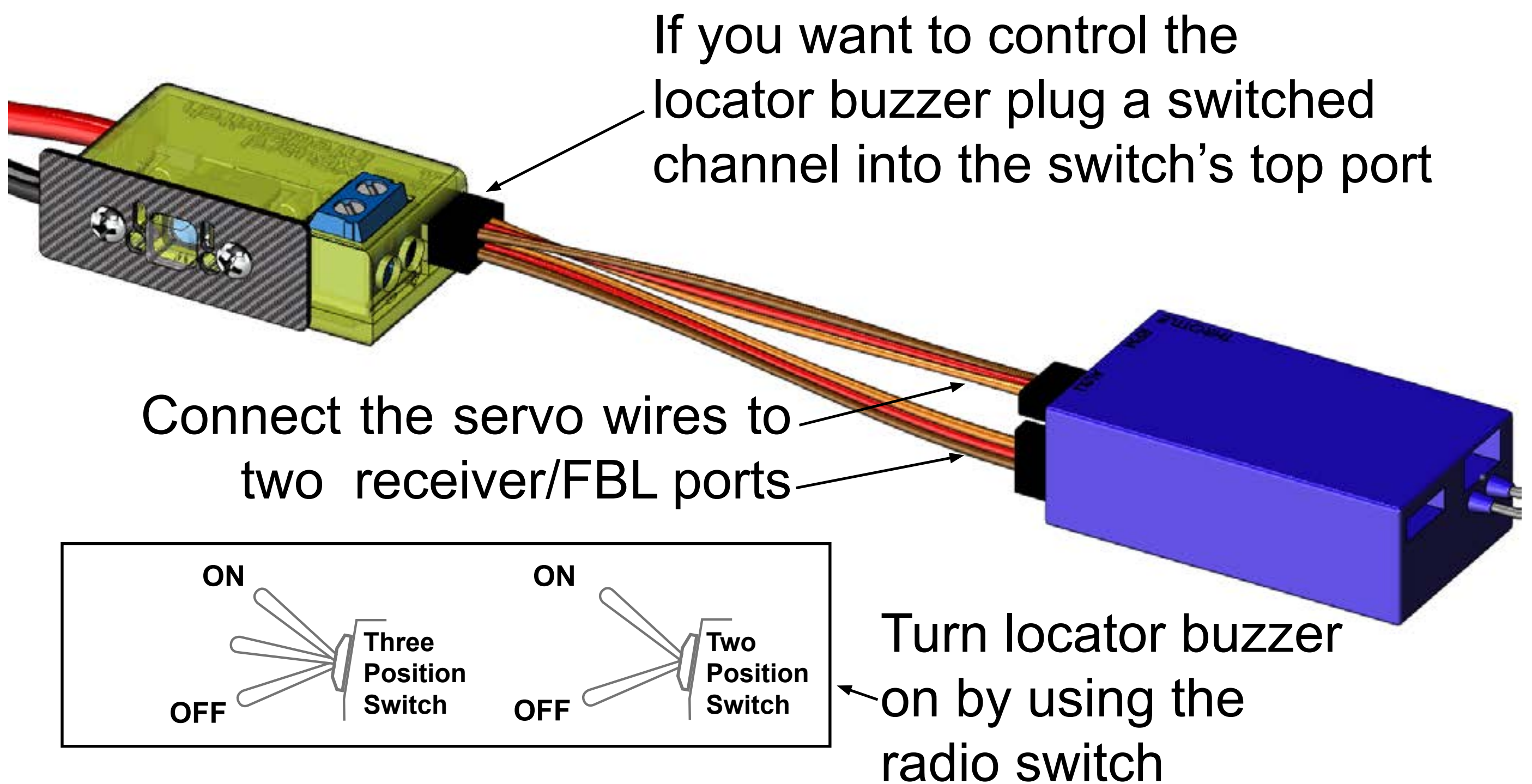

Note: If the positions are reversed go to the radio's setting screen and reverse the switch channel.

XGuard IntelliSwitch

SWITCH OPERATION

A) WHEN BATTERY IS FIRST CONNECTED TO THE SWITCH

Wait until the switch is armed and ready which is indicated by alternating blinking GREEN and RED LEDs.

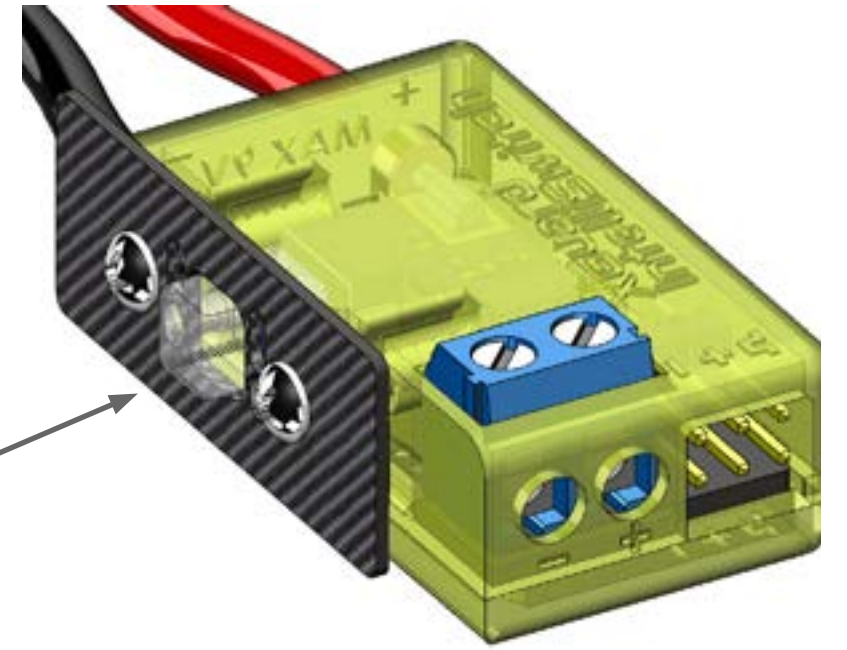

Once it's armed you can click once and the switch will turn on and send power to the output ports. The selected battery mode of operation is indicated by a series of beeps from 1 to 6 depending on what is programmed as the mode of operation. If not clicked ON within 3 seconds it will go to standby.

B) WHEN SWITCH IS ON STANDBY

If you turned the switch off via holding the the ON/OFF button for more than three seconds the switch turned OFF by entering into standby mode. When in standby mode you need to click once to arm the switch which is indicated by alternating blinking GREEN and RED LEDs.

Once it's armed you can click once and the switch will turn on and send power to the output ports. The selected battery mode of operation is indicated by a series of beeps from 1 to 6 depending on what is programmed as the mode of operation. If not clicked ON within 3 seconds it will go to standby.

XGuard IntelliSwitch

PROGRAMMING THE UNIT

The switch comes pre-programmed from factory for 2S LiPo with audible warnings and switch active.

If you want to change the settings you can program the switch for other battery types and to ignore the channel that activates the locator if so wanted.

The switch has the following programmable settings:

A) Type of battery and warning or no warning:

- 1 beep) 2S LiPo Battery with Audible and LED Voltage Warnings
- 2 beeps) 2S LiPo Battery with only LED Voltage Warnings
- 3 beeps) 5cell NiMh Battery with Audible and LED Voltage Warnings
- 4 beeps) 5cell NiMh Battery with only LED Voltage Warnings
- 5 beeps) 2S LiFe Battery with Audible and LED Voltage Warnings
- 6 beeps) 2S LiFe Battery with only LED Voltage Warnings

B) Ignore the switch signal

- 7 beeps) Ignore Locator Alarm Switch Signal

Lipo Warning voltage: 6.7V (3.35V per cell)
Lipo Emergency voltage: 6.1V (3.05V per cell)

NiMh Warning voltage: 5.2V (1.04V per cell)
NiMh Emergency voltage: 4.8V (0.96V per cell)

LiFe Emergency voltage: 6.2V (3.1V per cell)

ENTERING PROGRAMMING MODE

To enter programming mode: **Starting from a disconnected Battery state** power-up the switch and **click once the ON-button and quickly once again and hold for at least three seconds** then release and listen to the musical tone that indicates program mode entered.

Right away after the musical tone you will hear one beep then two beeps and so on until 6 beeps. If you click the button once after hearing the number of beeps that matches the programming setting you want it will select the type of battery and warnings as described in the list above from 1 to 6 and confirmation beeps matching the one you selected are played. Factory default is mode 1 beep for 2S Lipo with audible warnings.

After selecting your mode the unit will play SEVEN HIGH PITCH beeps to let you select if you want to **ignore** the locator buzzer switch signal from the radio. If you click to select this then the locator alarm will not be active with the switch.

Once you selected both your battery type/warning mode and whether you want the locator switch ignored or not you will hear another musical tone indicating that the unit is out of the programming mode and into normal operation.

QUICK PROGRAMMING SEQUENCE GUIDE

- Plug Battery
- Press button once and then immediately press again and hold for 3 seconds
- Wait for musical tones indicating programming mode starts
- Wait until number of beeps you want play and press button once to select
- Wait for the same number of beeps as confirmation
- Wait for 7 beeps and if you want to ignore the locator alarm switch press once
- If pressed after 7 beeps then wait for 7 confirmation beeps
- Wait for musical tones indicating programming mode exit

IMPORTANT NOTE: Programming can only be started by plugging a battery not from Standby.

MUSICAL TONES MEANING

NORMAL OPERATION:

- 1) Power UP tones (number of beeps (1-6) reflect programmed type of battery)

CLICK ON BOXES TO LISTEN

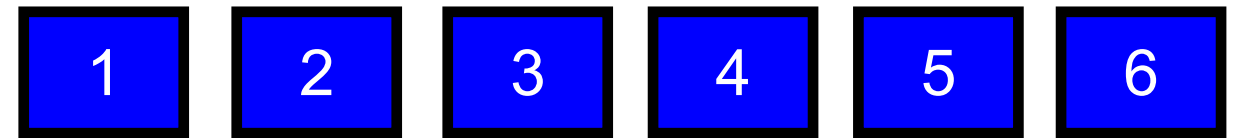

- 2) Power Down Tone (Musical tone)

PLAY SOUND

LOW VOLTAGE WARNING TONES:

- 1) Warning, battery voltage is low

PLAY SOUND

- 2) Emergency, battery too low do not operate aircraft.

PLAY SOUND

DURING PROGRAMMING:

- 1) Enter Programming Section

PLAY SOUND

- 2) Programing steps:

Mode tone for selecting:



Select confirmation tone:



- 3) Exit Programming Section

PLAY SOUND

XGuard IntelliSwitch

DIMENSIONS

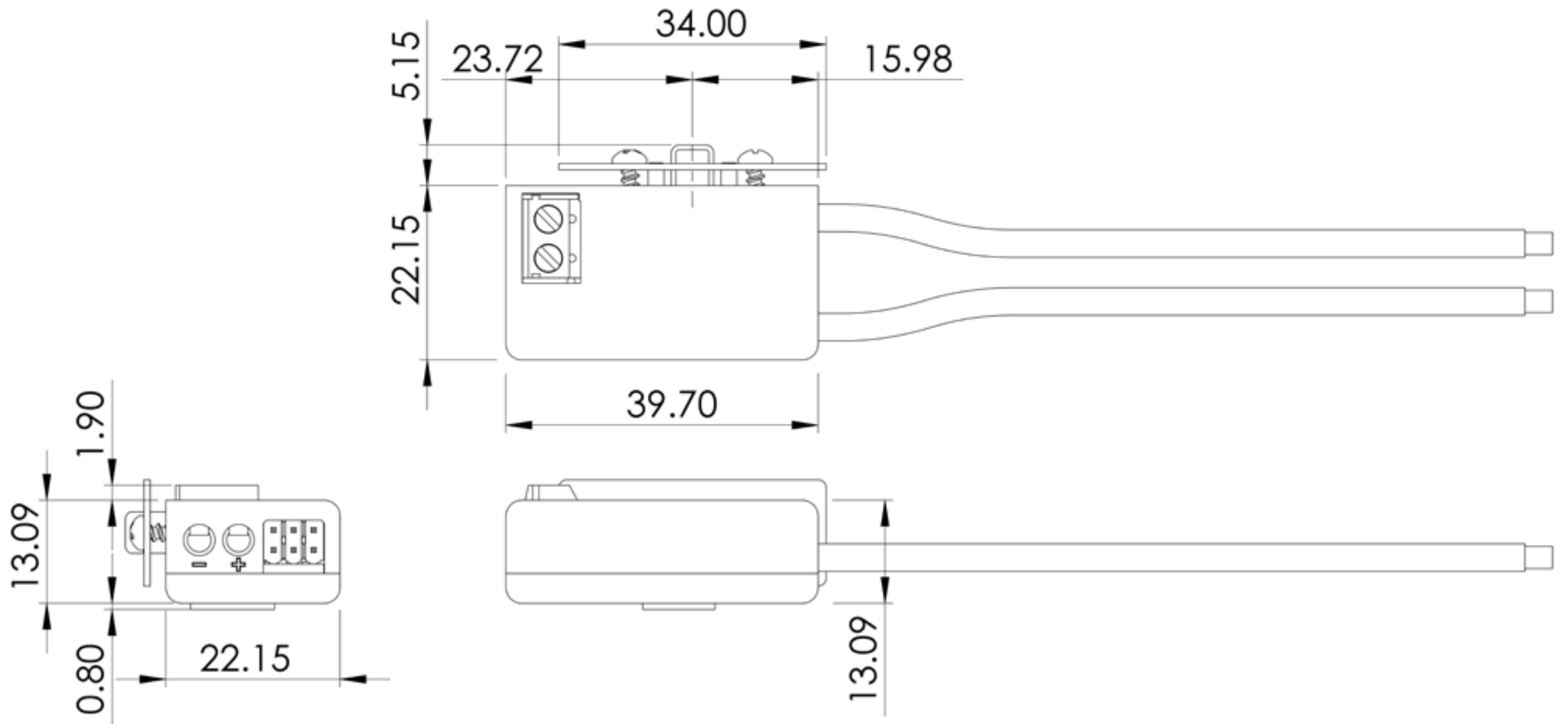

INSTALLATION HOLE PATTERN

